

FEATURES

Low offset voltage: 100 μV max
Low offset voltage drift: 2 $\mu\text{V}/^\circ\text{C}$ max
Low input bias current: 700 pA max
Low noise: 8 nV/ $\sqrt{\text{Hz}}$
High common-mode rejection: 118 dB min
Wide operating temperature: -40°C to $+85^\circ\text{C}$
No phase reversal

APPLICATIONS

Photodiode amplifier
Sensors and controls
Multipole filters
Integrator

GENERAL DESCRIPTION

The AD8698 is a high precision, rail-to-rail output, low noise, low input bias current operational amplifier. Offset voltage is a respectable 100 μV max and drift over temperature is below 2 $\mu\text{V}/^\circ\text{C}$, eliminating the need for manual offset trimming. The AD8698 is ideal for high impedance sensors, minimizing offset errors due to input bias and offset currents.

The rail-to-rail output maximizes dynamic range in a variety of applications, such as photodiode amplifiers, DAC I/V amplifiers, filters, and ADC input amplifiers.

The AD8698 dual amplifiers are offered in 8-lead MSOP and narrow 8-lead SOIC packages. The MSOP version is available in tape and reel only.

CONNECTION DIAGRAMS

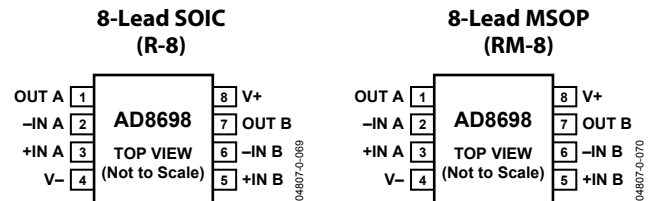

Figure 1.

Rev. 0

Information furnished by Analog Devices is believed to be accurate and reliable. However, no responsibility is assumed by Analog Devices for its use, nor for any infringements of patents or other rights of third parties that may result from its use. Specifications subject to change without notice. No license is granted by implication or otherwise under any patent or patent rights of Analog Devices. Trademarks and registered trademarks are the property of their respective owners.

TABLE OF CONTENTS

Specifications	3	Instrumentation Amplifier	15
Absolute Maximum Ratings	5	Composite Amplifier	15
Thermal Resistance	5	Low Noise Applications	16
ESD Caution.....	5	Driving ADCs	16
Typical Performance Characteristics.....	6	Using the AD8698 in Active Filter Designs	16
Applications	14	Outline Dimensions.....	17
Input Overvoltage Protection.....	14	Ordering Guide	17
Driving Capacitive Loads.....	14		

REVISION HISTORY

4/04—Revision 0: Initial Version

SPECIFICATIONS

$V_S = \pm 15\text{ V}$, $V_{CM} = 0\text{ V}$ (@ $T_A = 25^\circ\text{C}$, unless otherwise noted.)

Table 1.

Parameter	Symbol	Conditions	Min	Typ	Max	Unit
INPUT CHARACTERISTICS						
Offset Voltage	V_{OS}	$-40^\circ\text{C} < T_A < +85^\circ\text{C}$		20	100	μV
Offset Voltage Drift	$\Delta V_{OS}/\Delta T$	$-40^\circ\text{C} < T_A < +85^\circ\text{C}$		0.6	300	$\mu\text{V}/^\circ\text{C}$
Input Bias Current	I_B	$-40^\circ\text{C} < T_A < +85^\circ\text{C}$			700	pA
Input Offset Current	I_{OS}	$-40^\circ\text{C} < T_A < +85^\circ\text{C}$			1500	pA
Input Voltage Range	IVR	$-40^\circ\text{C} < T_A < +85^\circ\text{C}$	-13.5V		1500	pA
Common-Mode Rejection Ratio	CMRR	$V_{CM} = \pm 13.5\text{ V}$	118	132		dB
Large Signal Voltage Gain	A_{VO}	$R_L = 2\text{ k}\Omega$, $V_O = \pm 13.5\text{ V}$	900	1450		V/mV
Input Capacitance	C_{DIFF}			6.5		pF
	C_{CM}			4.6		pF
OUTPUT CHARACTERISTICS						
Output Voltage Swing (Ref. to GND)	V_{OH}	$I_L = 1\text{ mA}$, $-40^\circ\text{C} < T_A < +85^\circ\text{C}$	14.85	14.93		V
	V_{OH}	$I_L = 5\text{ mA}$, $-40^\circ\text{C} < T_A < +85^\circ\text{C}$	14.6	14.8		V
(Ref. to GND)	V_{OL}	$I_L = 1\text{ mA}$, $-40^\circ\text{C} < T_A < +85^\circ\text{C}$		-14.93	-14.6	V
	V_{OL}	$I_L = 5\text{ mA}$, $-40^\circ\text{C} < T_A < +85^\circ\text{C}$		-14.82	-14.5	V
POWER SUPPLY						
Power Supply Rejection Ratio	PSRR	$\pm 2.5\text{ V} < V_S < \pm 15\text{ V}$	114	132		dB
Supply Current	I_{SY}	$V_O = 0\text{ V}$ $-40^\circ\text{C} < T_A < +85^\circ\text{C}$		2.8	3.2	mA
Supply Voltage	V_S	$-40^\circ\text{C} < T_A < +85^\circ\text{C}$	± 2.5		± 15	V
DYNAMIC PERFORMANCE						
Slew Rate	SR	$R_L = 2\text{ k}\Omega$		0.4		$\text{V}/\mu\text{s}$
Gain Bandwidth Product	GBP			1		MHz
Phase Margin	ϕ_O				60	Degrees
NOISE PERFORMANCE						
Input Noise Voltage	$e_n\text{ p-p}$	$0.1\text{ Hz} < f < 10\text{ Hz}$		0.6		$\mu\text{V p-p}$
Input Voltage Noise Density	e_n	$f = 10\text{ Hz}$		15		$\text{nV}/\sqrt{\text{Hz}}$
Input Voltage Noise Density	e_n	$f = 1\text{ kHz}$		8		$\text{nV}/\sqrt{\text{Hz}}$
Current Noise Density	i_n	$f = 1\text{ kHz}$		0.2		$\text{pA}/\sqrt{\text{Hz}}$

AD8698

$V_S = \pm 2.5\text{ V}$, $V_{CM} = 0\text{ V}$ (@ $T_A = 25^\circ\text{C}$, unless otherwise noted.)

Table 2.

Parameter	Symbol	Conditions	Min	Typ	Max	Unit
INPUT CHARACTERISTICS						
Offset Voltage	V_{OS}	$-40^\circ\text{C} < T_A < +85^\circ\text{C}$		20	100	μV
Offset Voltage Drift	$\Delta V_{OS}/\Delta T$	$-40^\circ\text{C} < T_A < +85^\circ\text{C}$			300	$\mu\text{V}/^\circ\text{C}$
Input Bias Current	I_B	$-40^\circ\text{C} < T_A < +85^\circ\text{C}$			700	pA
Input Offset Current	I_{OS}	$-40^\circ\text{C} < T_A < +85^\circ\text{C}$			1500	pA
Input Voltage Range	IVR	$-40^\circ\text{C} < T_A < +85^\circ\text{C}$	-1.5		+1.5	V
Common-Mode Rejection Ratio	CMRR	$V_{CM} = \pm 13.5\text{ V}$	105	120		dB
Large Signal Voltage Gain	A_{VO}	$R_L = 2\text{ k}\Omega$, $V_O = \pm 13.5\text{ V}$	600	1200		V/mV
Input Capacitance	C_{DIFF}			6.4		pF
	C_{CM}			4.6		pF
OUTPUT CHARACTERISTICS						
Output Voltage Swing (Ref. to GND)	V_{OH}	$I_L = 1\text{ mA}$, $-40^\circ\text{C} < T_A < +85^\circ\text{C}$	2.35	2.44		V
	V_{OH}	$I_L = 5\text{ mA}$, $-40^\circ\text{C} < T_A < +85^\circ\text{C}$	2.1	2.29		V
Output Voltage Swing (Ref. to GND)	V_{OL}	$I_L = 1\text{ mA}$, $-40^\circ\text{C} < T_A < +85^\circ\text{C}$		-2.43	-2.2	V
	V_{OL}	$I_L = 5\text{ mA}$, $T_A = 25^\circ\text{C}$		-2.15	-1.9	V
		$I_L = 5\text{ mA}$, $-40^\circ\text{C} < T_A < +85^\circ\text{C}$			-1.6	V
POWER SUPPLY						
Power Supply Rejection Ratio	PSRR	$\pm 2.5\text{ V} < V_S < \pm 15\text{ V}$	114	132		dB
Supply Current	I_{SY}	$V_O = 0\text{ V}$ $-40^\circ\text{C} < T_A < +85^\circ\text{C}$		2.3	2.8	mA
		$-40^\circ\text{C} < T_A < +85^\circ\text{C}$			3.3	mA
Supply Voltage	V_S	$-40^\circ\text{C} < T_A < +85^\circ\text{C}$	± 2.5		± 15	V
DYNAMIC PERFORMANCE						
Slew Rate	SR	$R_L = 2\text{ k}\Omega$		0.4		$\text{V}/\mu\text{s}$
Gain Bandwidth Product	GBP			1		MHz
Phase Margin	ϕ_o			60		Degrees
NOISE PERFORMANCE						
Input Noise Voltage	$e_n\text{ p-p}$	$0.1\text{ Hz} < f < 10\text{ Hz}$		0.6		$\mu\text{V p-p}$
Input Voltage Noise Density	e_n	$f = 10\text{ Hz}$		15		$\text{nV}/\sqrt{\text{Hz}}$
Input Voltage Noise Density	e_n	$f = 1\text{ kHz}$		8		$\text{nV}/\sqrt{\text{Hz}}$
Current Noise Density	i_n	$f = 1\text{ kHz}$		0.2		$\text{pA}/\sqrt{\text{Hz}}$

ABSOLUTE MAXIMUM RATINGS

Table 3.

Parameter	Rating
Supply Voltage	± 15 V
Input Voltage	$\pm V_S$
Differential Input Voltage	$\pm V_S$
Output Short-Circuit Duration to Gnd	Indefinite
Storage Temperature Range R, RM Packages	-65°C to $+150^{\circ}\text{C}$
Operating Temperature Range	-40°C to $+85^{\circ}\text{C}$
Junction Temperature Range R, RM Packages	-65°C to $+150^{\circ}\text{C}$
Lead Temperature Range (Soldering, 60 Sec)	$+300^{\circ}\text{C}$

Stresses above those listed under Absolute Maximum Ratings may cause permanent damage to the device. This is a stress rating only; functional operation of the device at these or any other conditions above those indicated in the operational section of this specification is not implied. Exposure to absolute maximum rating conditions for extended periods may affect device reliability.

ESD CAUTION

ESD (electrostatic discharge) sensitive device. Electrostatic charges as high as 1000 V readily accumulate on the human body and test equipment and can discharge without detection. Although this product features proprietary ESD protection circuitry, permanent damage may occur on devices subjected to high energy electrostatic discharges. Therefore, proper ESD precautions are recommended to avoid performance degradation or loss of functionality.



THERMAL RESISTANCE

θ_{JA} is specified for the worst-case conditions, i.e., θ_{JA} is specified for devices soldered in circuit boards for surface-mount packages.

Table 4. Thermal Resistance

Package Type	θ_{JA}	θ_{JC}	Unit
MSOP-8 (RM)	210	45	$^{\circ}\text{C}/\text{W}$
SOIC-8 (R)	158	43	$^{\circ}\text{C}/\text{W}$

TYPICAL PERFORMANCE CHARACTERISTICS

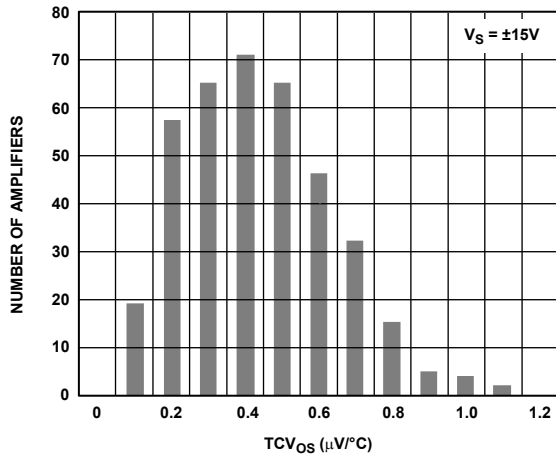

Figure 2. Input Offset Voltage Drift Distribution

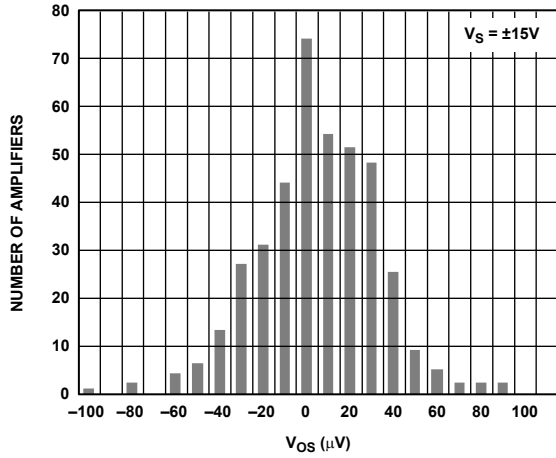

Figure 3. Offset Voltage Distribution

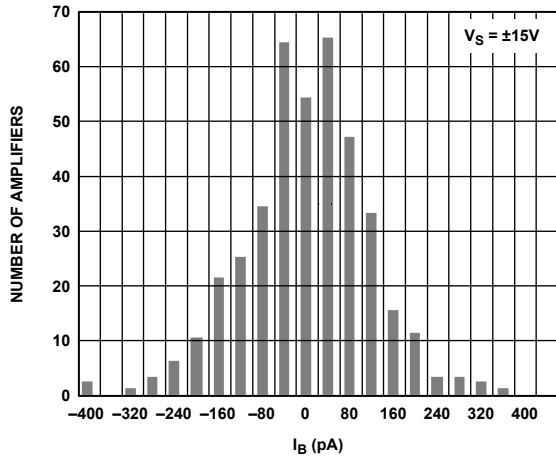

Figure 4. Input Bias Distribution

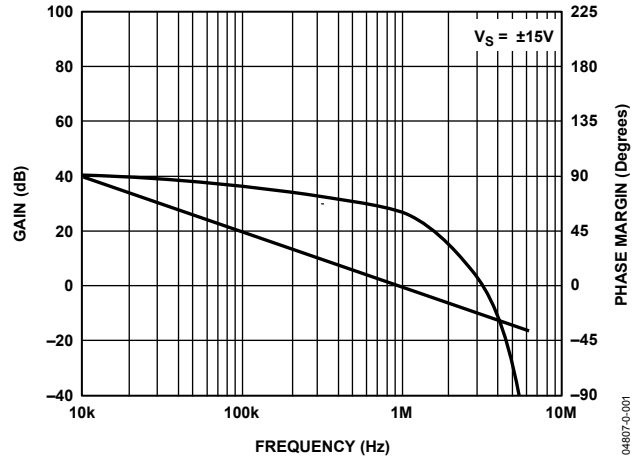

Figure 5. Open-Loop Gain and Phase vs. Frequency

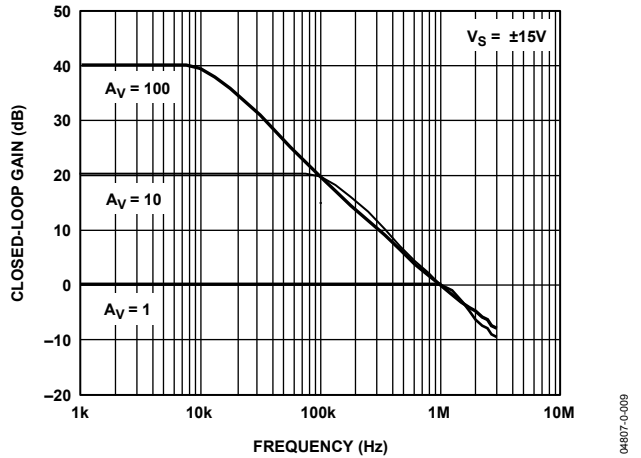

Figure 6. Closed-Loop Gain vs. Frequency

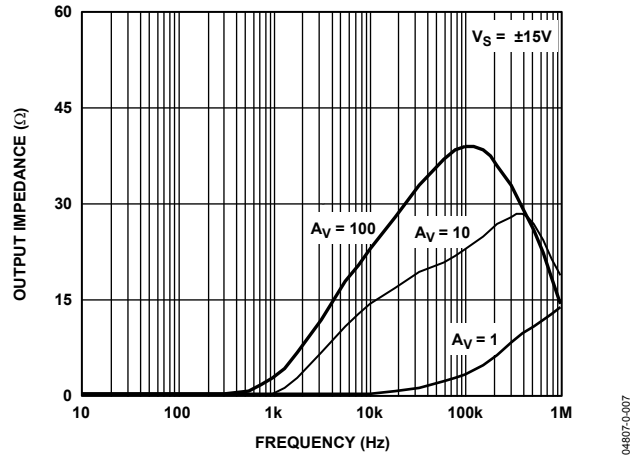

Figure 7. Output Impedance vs. Frequency

04807-0-034

04807-0-058

04807-0-060

04807-0-001

04807-0-009

04807-0-007

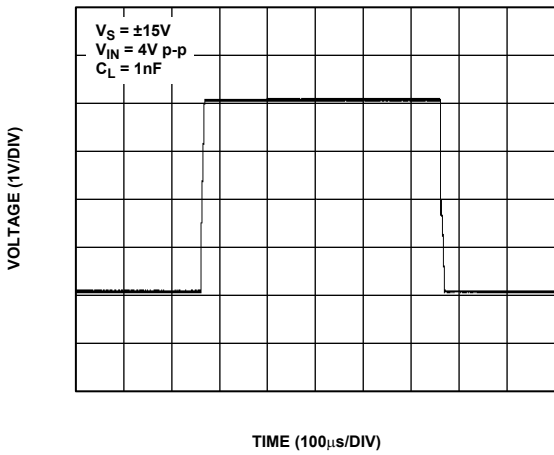

Figure 8. Large Signal Transient Response

04807-0-037

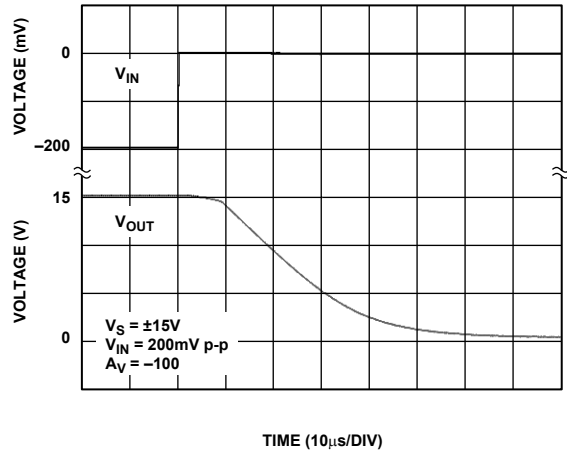

Figure 11. Positive Overvoltage Recovery

04807-0-041

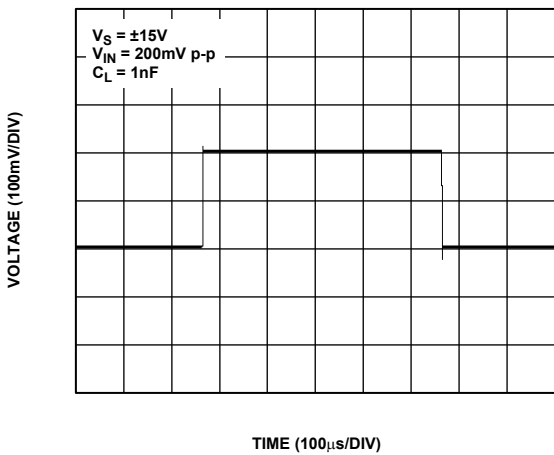

Figure 9. Small Signal Transient Response

04807-0-044

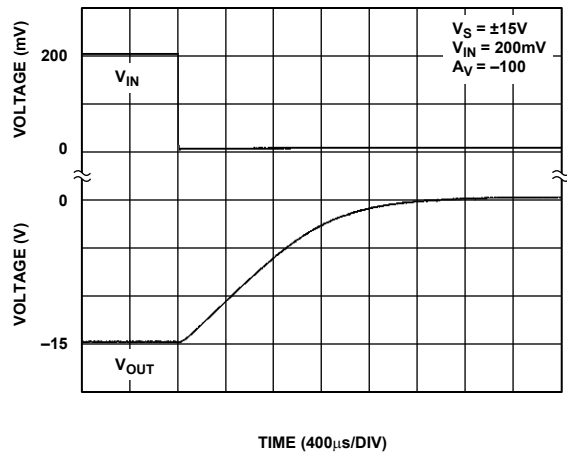

Figure 12. Negative Overvoltage Recovery

04807-0-040

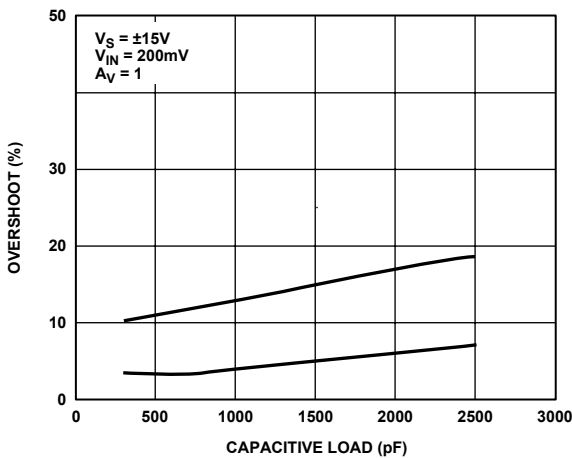

Figure 10. Overshoot vs. Load Capacitance

04807-0-013

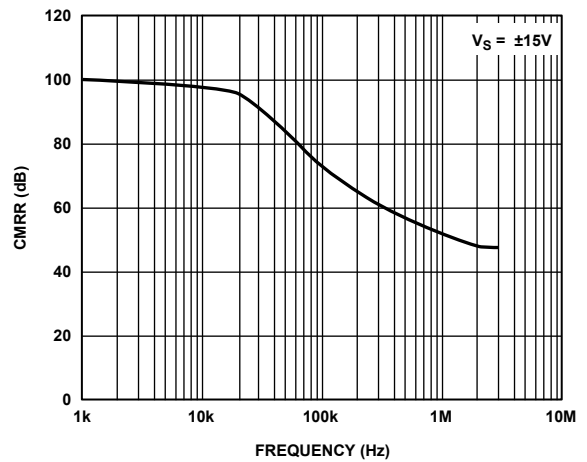

Figure 13. CMRR vs. Frequency

04807-0-003

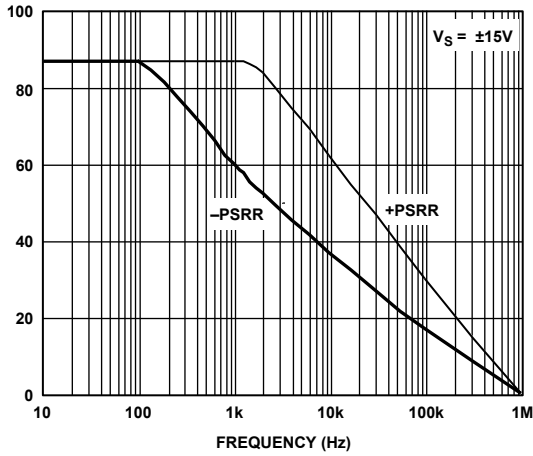

Figure 14. PSRR vs. Frequency

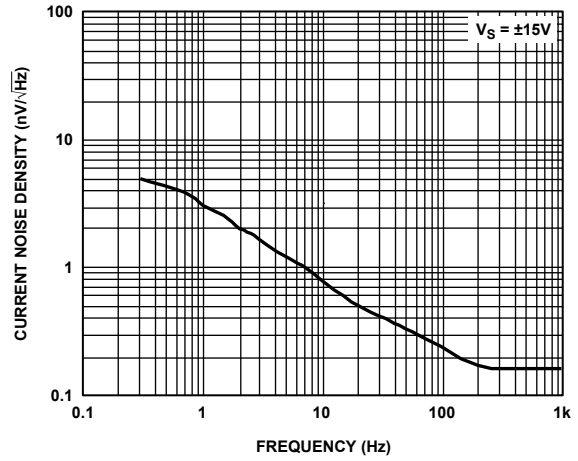

Figure 17. Current Noise Density vs. Frequency

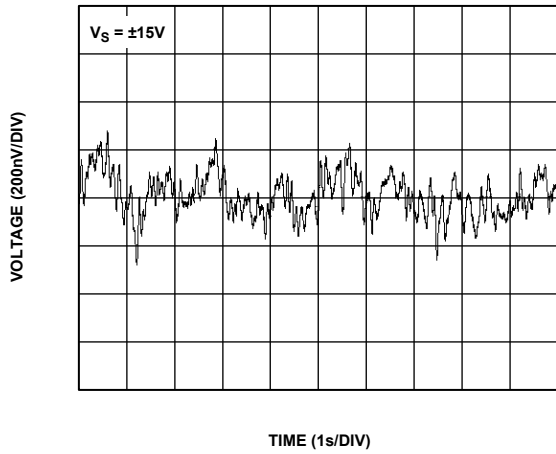

Figure 15. Input Voltage Noise

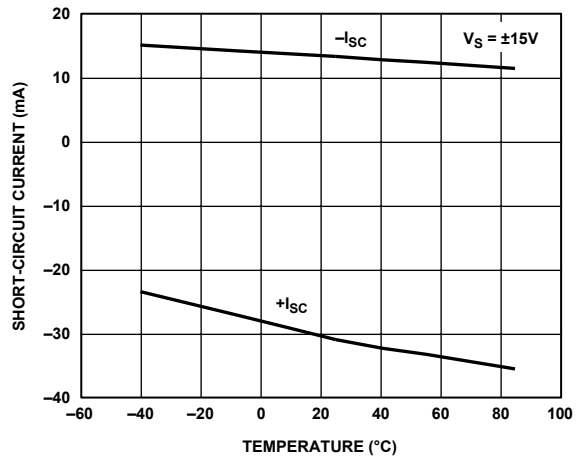

Figure 18. Short-Circuit Current vs. Temperature

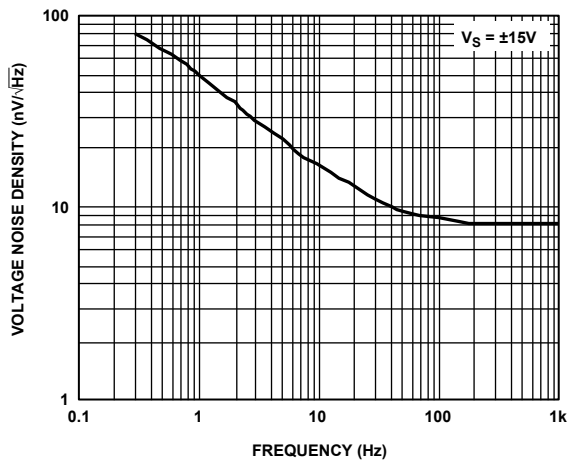

Figure 16. Voltage Noise Density vs. Frequency

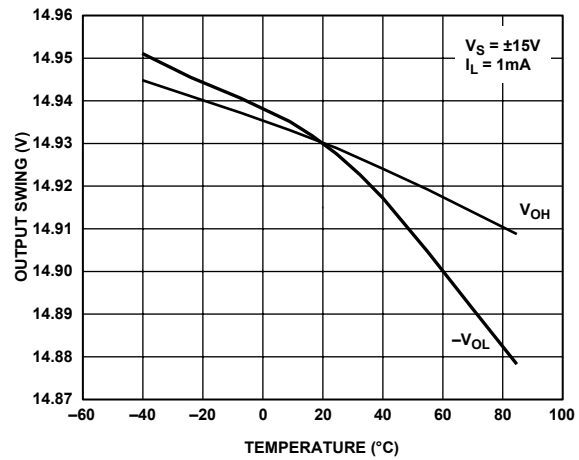

Figure 19. Output Swing vs. Temperature

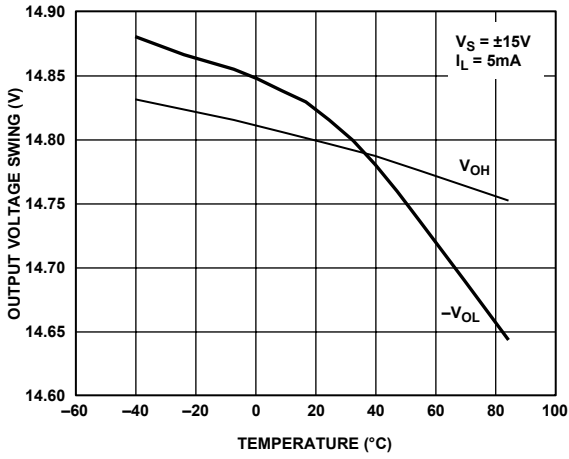

Figure 20. Output Voltage Swing vs. Temperature

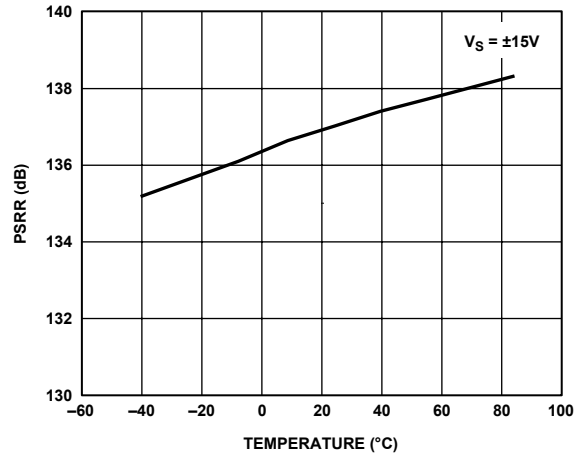

Figure 23. PSRR vs. Temperature

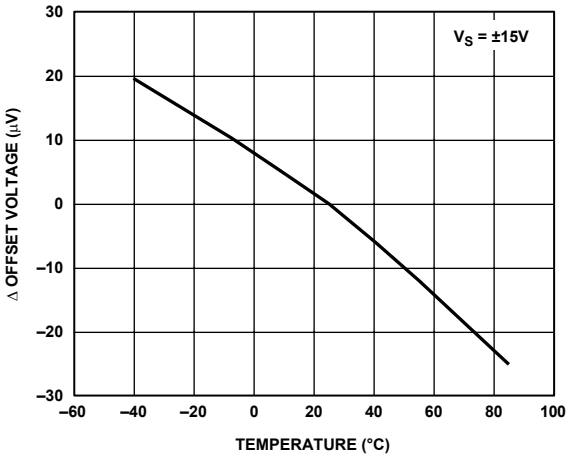

Figure 21. Δ Offset Voltage vs. Temperature

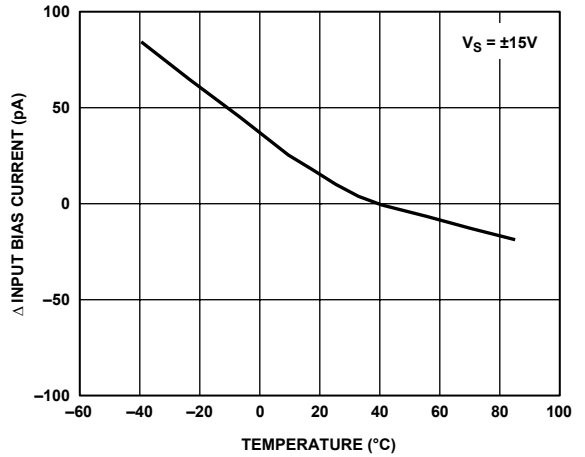

Figure 24. Δ Input Bias Current vs. Temperature

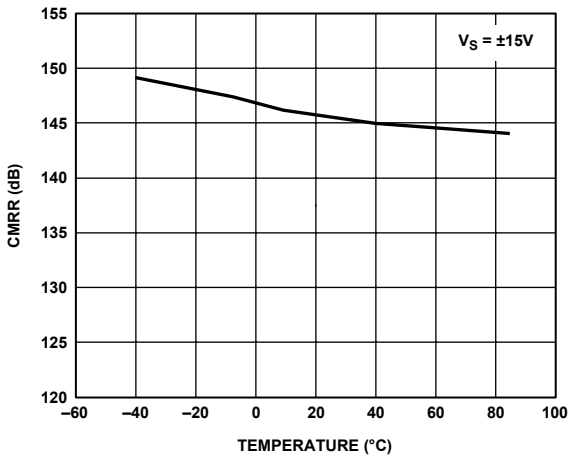

Figure 22. CMRR vs. Temperature

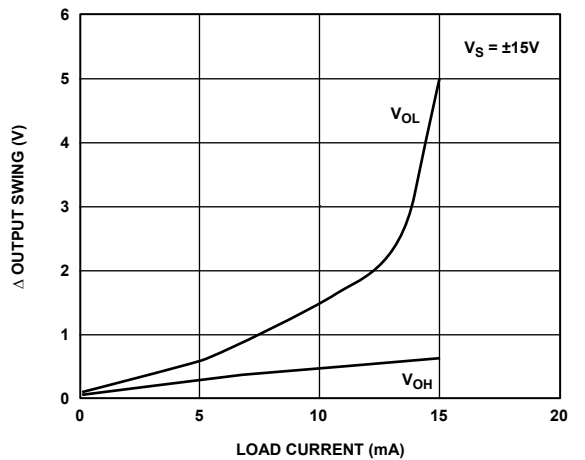

Figure 25. Δ Output Voltage Swing from Rails vs. Load Current

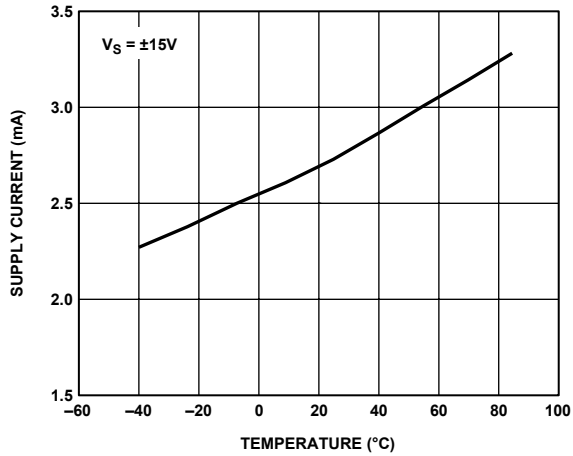

Figure 26. Supply Current vs. Temperature

04807-0-017

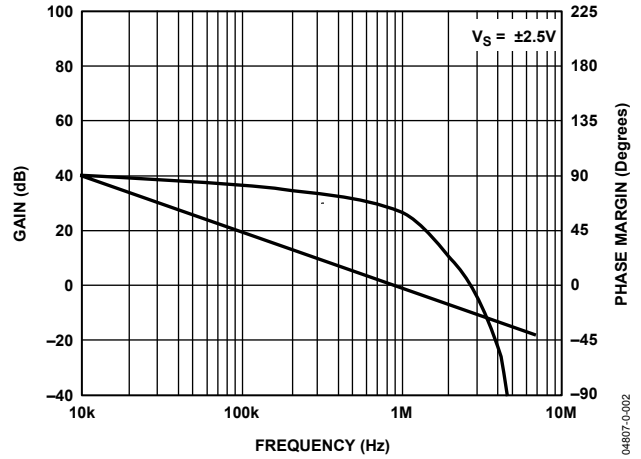

Figure 29. Open-Loop Gain and Phase vs. Frequency

04807-0-002

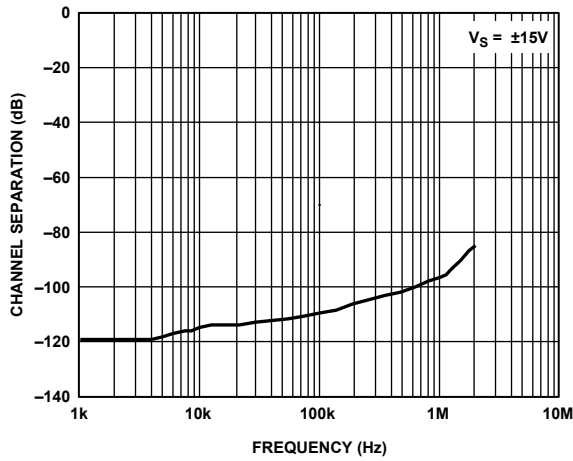

Figure 27. Channel Separation

04807-0-010

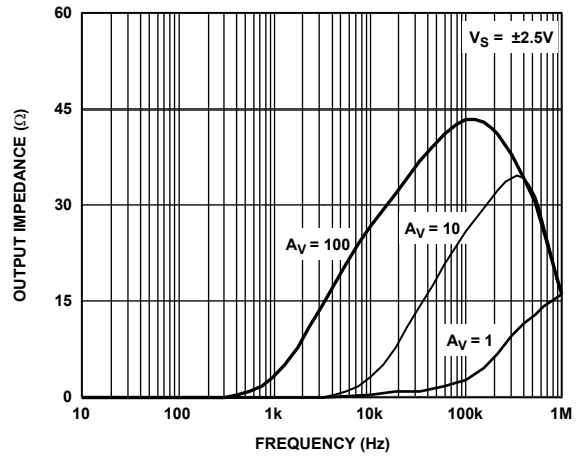

Figure 30. Output Impedance vs. Frequency

04807-0-008

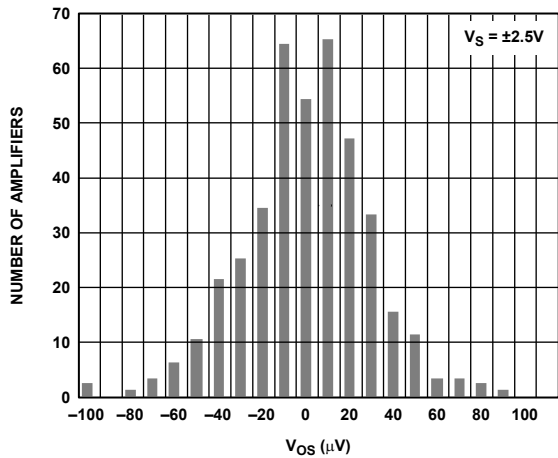

Figure 28. Offset Voltage Distribution

04807-0-059

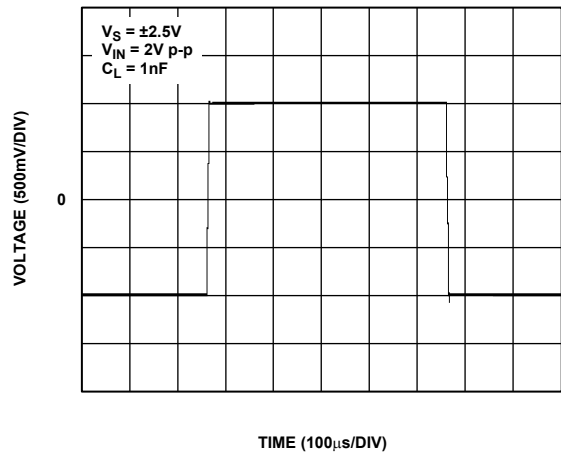

Figure 31. Large Signal Transient Response

04807-0-038

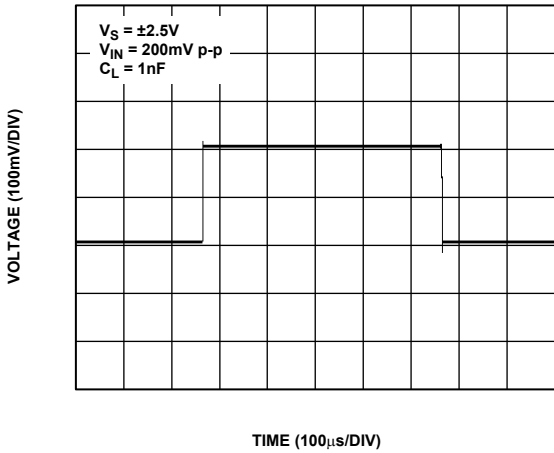

Figure 32. Small Signal Transient Response

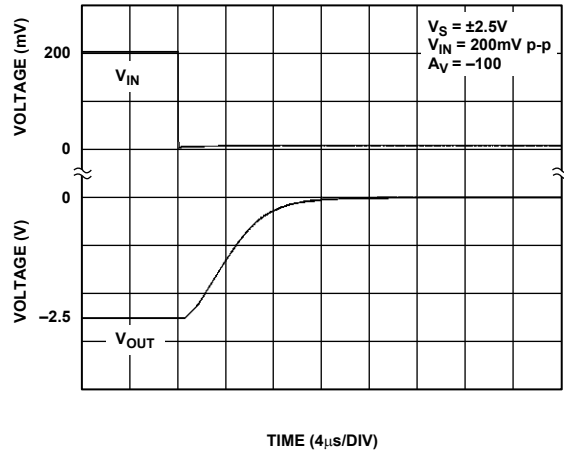

Figure 35. Negative Overvoltage Recovery

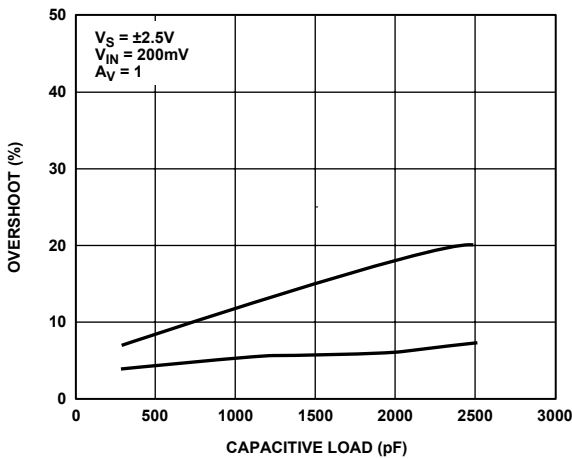

Figure 33. Overshoot vs. Load Capacitance

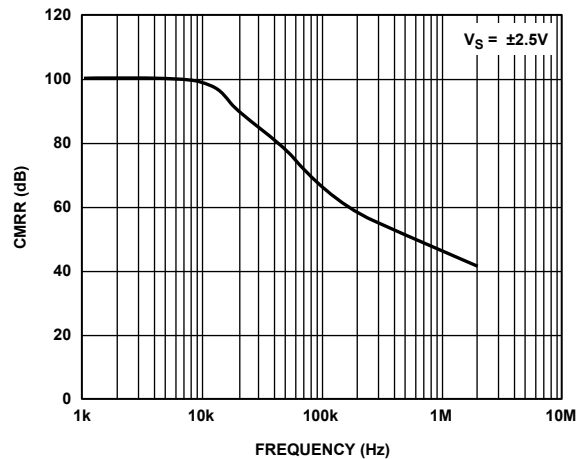

Figure 36. CMRR vs. Frequency

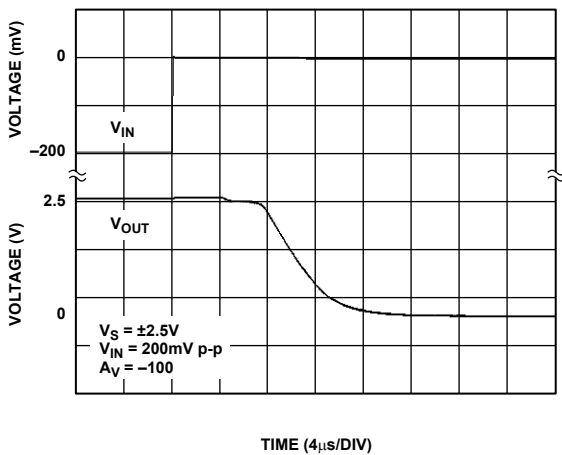

Figure 34. Positive Overvoltage Recovery

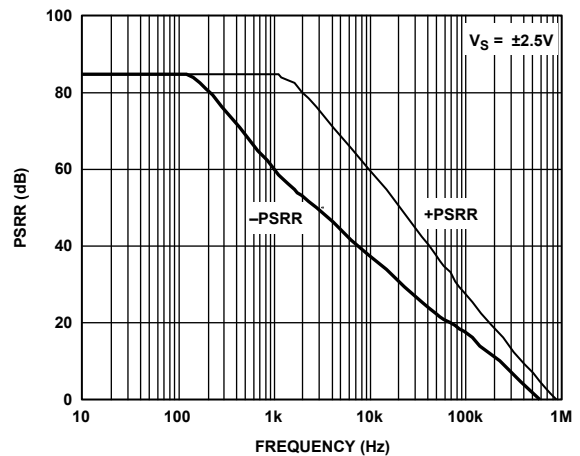

Figure 37. PSRR vs. Frequency

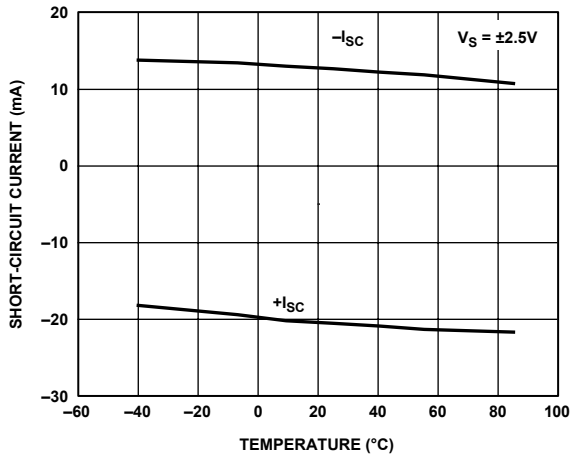

Figure 38. Short-Circuit Current vs. Temperature

04807-0-031

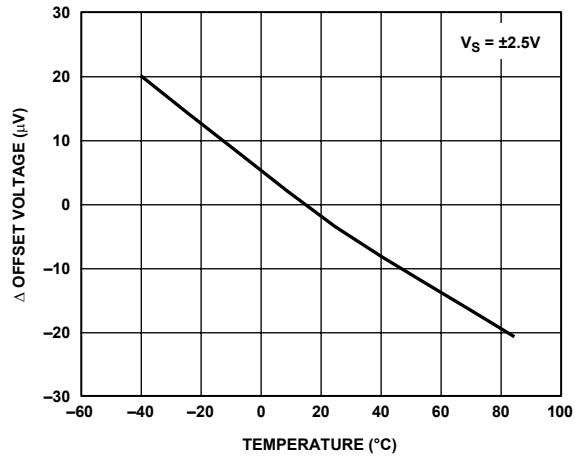

Figure 41. Δ Offset Voltage vs. Temperature

04807-0-024

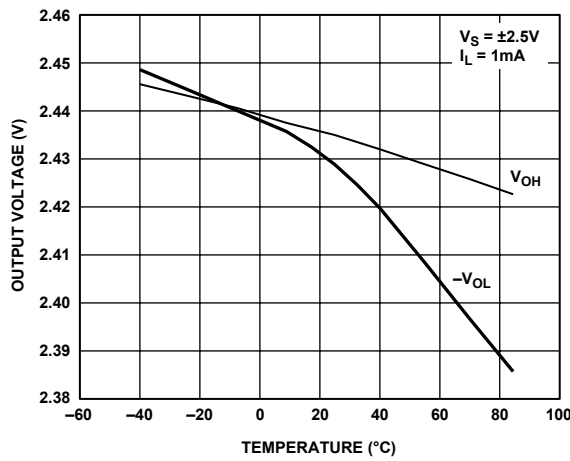

Figure 39. Output Swing vs. Temperature

04807-0-021

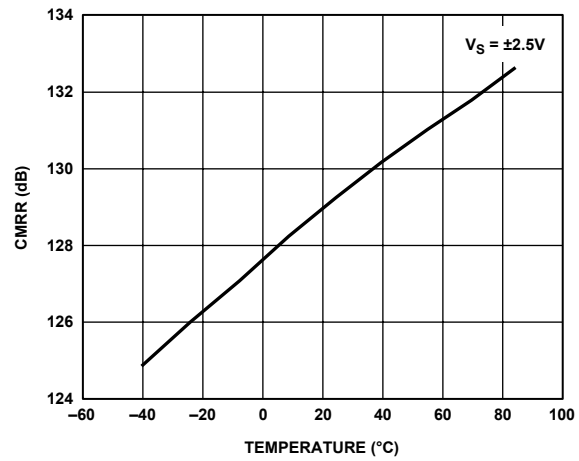

Figure 42. CMRR vs. Temperature

04807-0-028

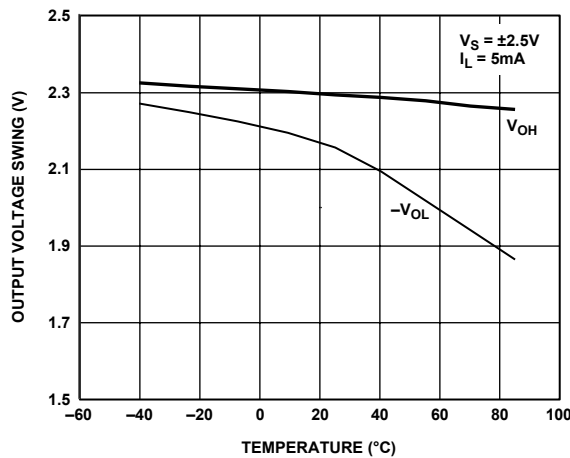

Figure 40. Output Voltage Swing vs. Temperature

04807-0-022

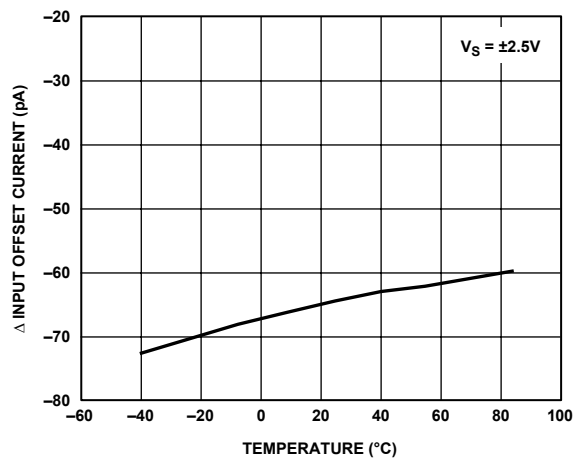

Figure 43. Δ Input Bias Current vs. Temperature

04807-0-026

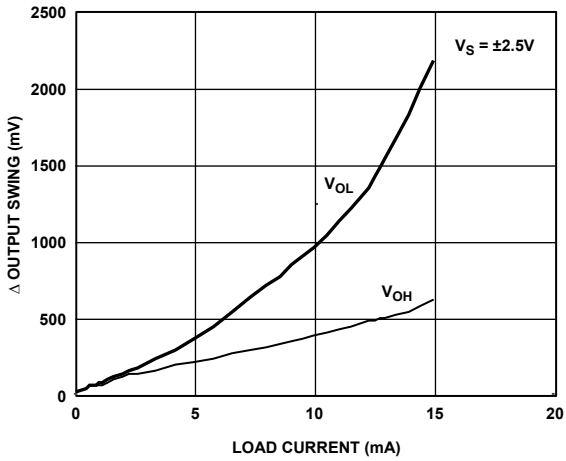

Figure 44. Δ Output Voltage Swing from Rails vs. Load Current

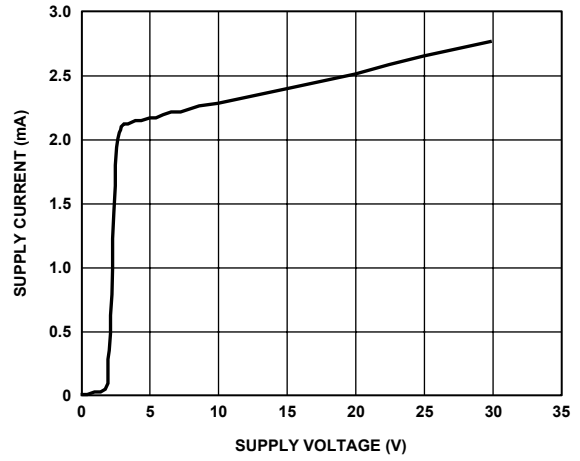

Figure 47. Supply Current vs. Supply Voltage

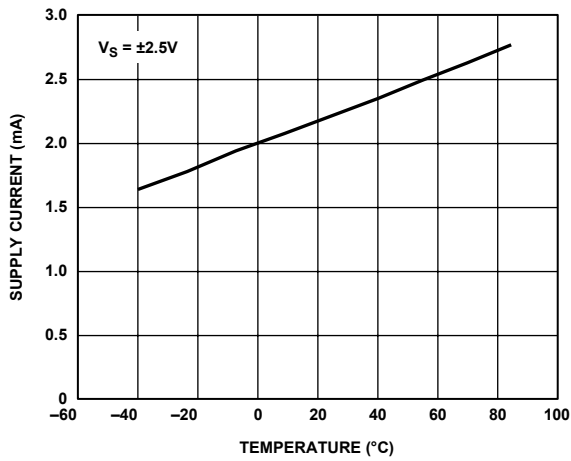

Figure 45. Supply Current vs. Temperature

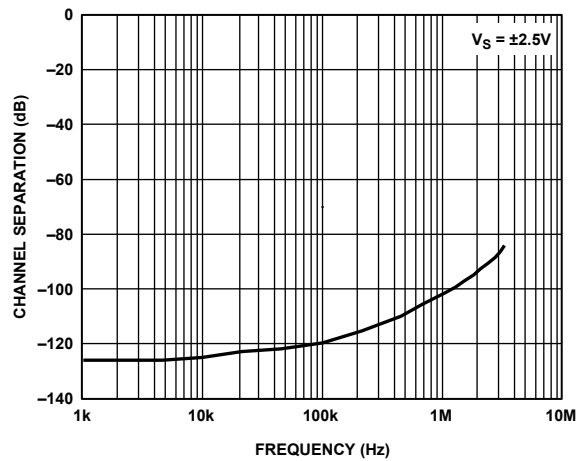

Figure 48. Channel Separation

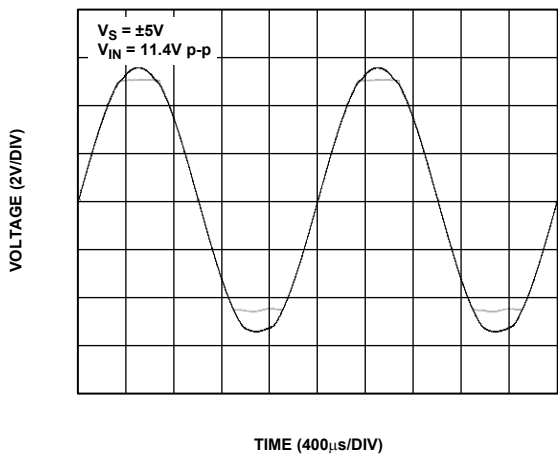

Figure 46. No Phase Reversal

04807-0-016

04807-0-012

04807-0-018

04807-0-011

04807-0-039

APPLICATIONS

INPUT OVERVOLTAGE PROTECTION

The AD8698 has internal protective circuitry which allows voltages at either input to exceed the supply voltage. However, if voltages applied at either input exceed the supply voltage by more than 2 V, it is recommended to use a resistor in series with the inputs to limit the input current and prevent damaging the device.

The value of the resistor can be calculated from the following formula:

$$\frac{V_{IN} - V_S}{R_S + 500} \leq 5 \text{ mA}$$

DRIVING CAPACITIVE LOADS

The AD8698 is stable even when driving heavy capacitive loads in any configuration. Although the AD8698 will safely drive capacitive loads well over 10 nF, it is recommended to use external compensation should the amplifier be subjected to driving a load exceeding 50 nF. This is particularly important in positive unity gain configurations, the worst case for stability. Figure 49 shows the output of the AD8698 with a 68 nF load in response to a 400 mV signal at its positive input; the overshoot is less than 25% without any external compensation. Using a simple “snubber” network reduces the overshoot to less than 10% as shown in Figure 50.

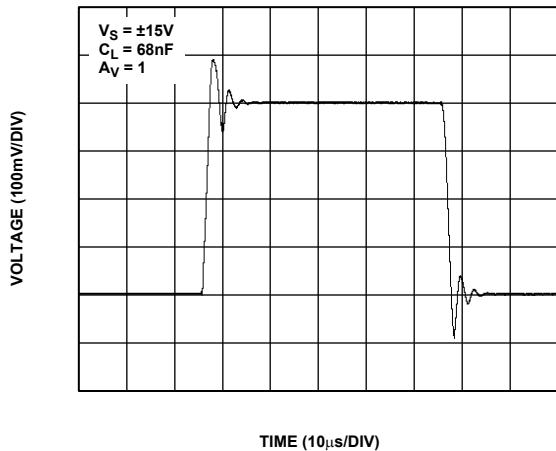

Figure 49. Heavy Capacitive Load Drive without Compensation

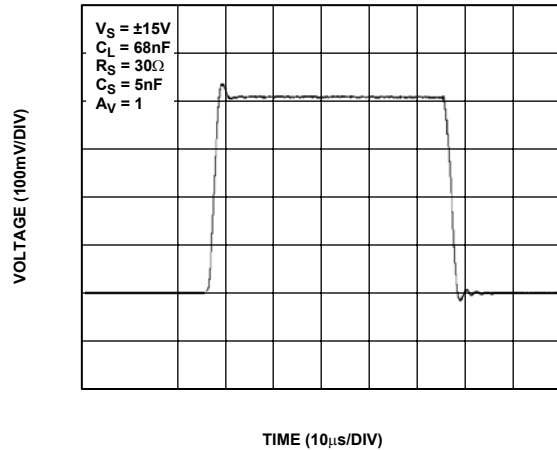

Figure 50. Compensated Capacitive Load Drive with Snubber

The snubber network consists of a simple RC network whose values are determined empirically.

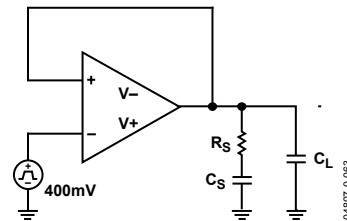

Figure 51. Snubber Network

Table 5 provides a few starting values for optimum compensation.

Table 5. Compensation Values

CL (nF)	RS (Ω)	CS (nF)
47	20	7
68	30	5
100	50	3

The use of the snubber network does not recover the loss of bandwidth incurred by the load capacitance. The AD8698 maintains a unity gain bandwidth of 1 MHz with load capacitances of up to 1 nF.

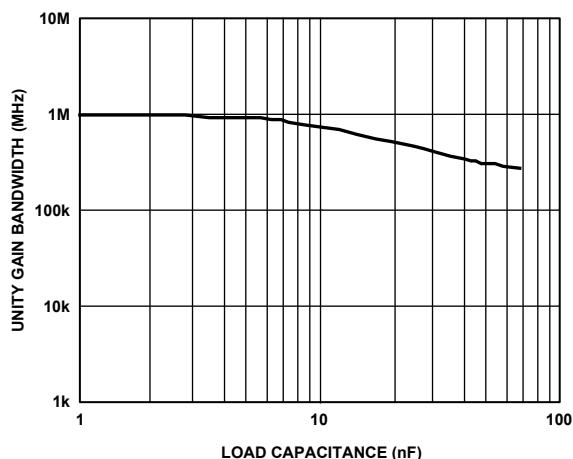

Figure 52. Unity Gain Bandwidth vs. Load Capacitance

Figure 52 shows the unity gain bandwidth as a function of load capacitance.

INSTRUMENTATION AMPLIFIER

Instrumentation amplifiers are used in applications requiring precision, accuracy, and high CMRR. One popular application is signal conditioning in process control, test automation, and measurement instrumentation, where the amplifier is used to amplify small signals.

The triple op amp implementation uses the AD8698 at the front end with the OP184 for optimum accuracy.

The circuit in Figure 53 enjoys a high overall gain, excellent dc performance, high CMRR, as well as the benefit of an output that swings to the supplies.

The CMRR of the in-amp will be limited by the choice of resistor tolerance. R5 is an optional potentiometer that can be used to calibrate the circuit for maximum gain. R7 can be trimmed for optimum CMRR.

The output voltage is given by:

$$V_O = V_{IN} \left(1 + \frac{2R3}{R4} \right) \left(\frac{R2}{R1} \right)$$

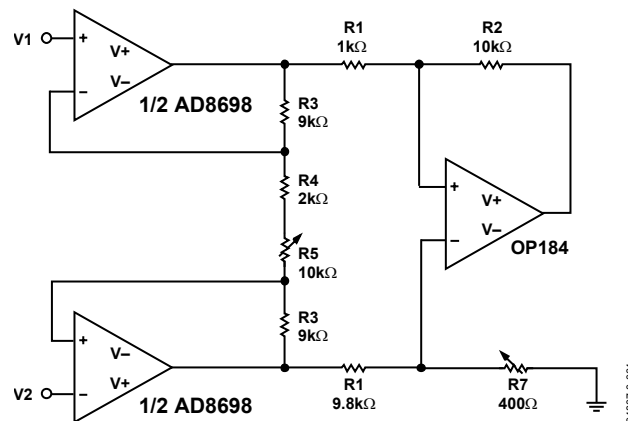

Figure 53. Three Op Amp In-Amp

COMPOSITE AMPLIFIER

The dc accuracy of the AD8698 and the ac performance of the OP184 are combined in the circuit shown in Figure 54. The composite amplifier provides a higher bandwidth, a lower offset voltage, and a higher loop, thereby reducing the gain error substantially.

The circuit shown exhibits a total output rms noise of less than 500 μV, corresponding to less than 3 mV of peak-to-peak noise over approximately a 3 MHz bandwidth. Cf is used to minimize peaking.

The circuit has an inverting gain of 10. In applications with higher closed-loop gains, Cf is necessary to maintain a sufficient phase margin and ensure stability. This results in a narrower closed-loop bandwidth.

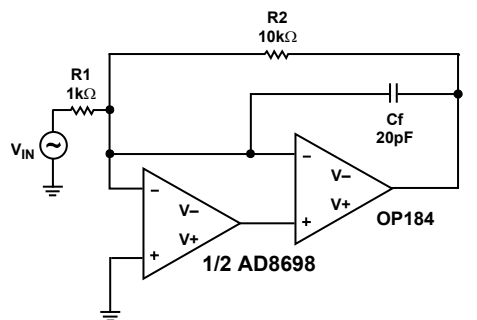

Figure 54. Composite Amplifier Circuit

LOW NOISE APPLICATIONS

In some applications, it is critical to minimize the noise, and although the AD8698 has a low noise of typically $8 \text{ nV}/\sqrt{\text{Hz}}$ at 1 kHz, paralleling the two amplifiers within the same package reduces the total noise referred to the input to approximately $5.5 \text{ nV}/\sqrt{\text{Hz}}$. This simple technique is depicted in Figure 55.

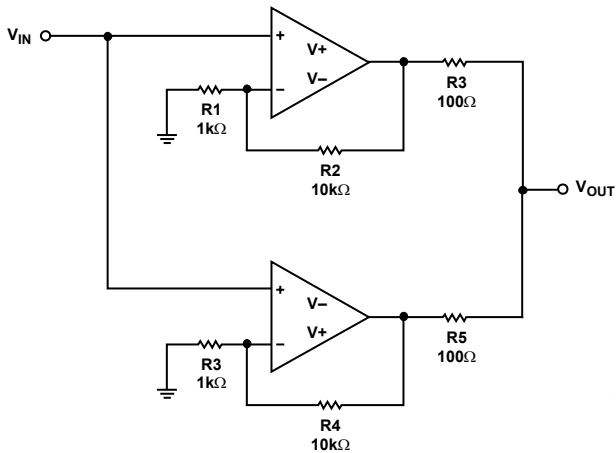

Figure 55. Paralleling Amplifiers

DRIVING ADCs

The AD8698 can drive extremely heavy capacitive loads without any compensation. Sometimes capacitors are placed at the output of the amplifier to absorb transient currents while the op amp is interfaced with the ADC. Most op amps need a small resistor with the output to isolate the load capacitance.

This results in a loss of bandwidth and slows the amplifier down substantially. However, the AD8698 maintains a unity gain bandwidth of 1 MHz with loads of up to 1 nF, as shown in Figure 52.

USING THE AD8698 IN ACTIVE FILTER DESIGNS

The AD8698 is recommended for unity gain filter designs with a corner frequency of up to 100 kHz, one tenth of the op amp's unity gain bandwidth.

If a higher gain is desired, the corner frequency should be chosen accordingly. For example, if the amplifier is configured with a gain of 10, the corner frequency of the filter should not be more than 10 kHz.

An example of an active filter is the Sallen Key. This topology gives the user the flexibility of implementing a low-pass or a high-pass filter by simply interchanging the resistors and the capacitors.

In the high-pass filter of Figure 56, the damping factor Q is set to $1/\sqrt{2}$ for a maximally flat response (Butterworth).

The gain is unity and the bandwidth is 10 kHz with the values shown.

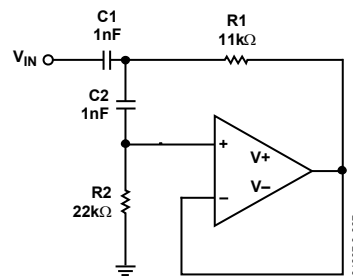

Figure 56. Two Pole High-Pass Filter

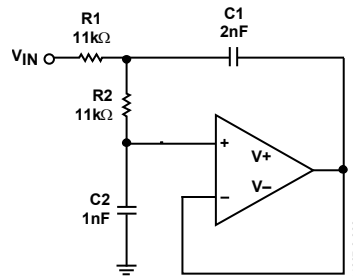
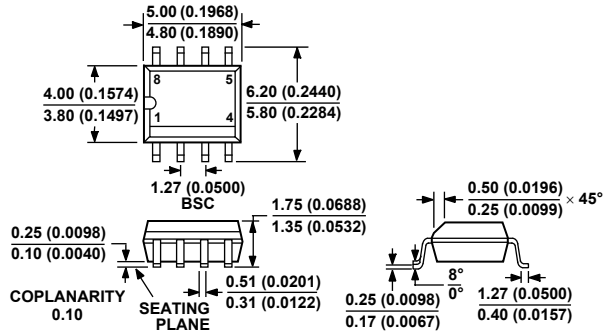

Figure 57. Two Pole Low-Pass Filter

The circuit of Figure 57 has a bandwidth of 10 kHz and a maximally flat response. In this case, the damping factor is controlled by the ratio of the capacitors and the gain is unity.

OUTLINE DIMENSIONS



COMPLIANT TO JEDEC STANDARDS MS-012AA
 CONTROLLING DIMENSIONS ARE IN MILLIMETERS; INCH DIMENSIONS
 (IN PARENTHESES) ARE ROUNDED-OFF MILLIMETER EQUIVALENTS FOR
 REFERENCE ONLY AND ARE NOT APPROPRIATE FOR USE IN DESIGN

Figure 58. 8-Lead Small Outline IC [SOIC] (R-8)—Dimensions shown in millimeters

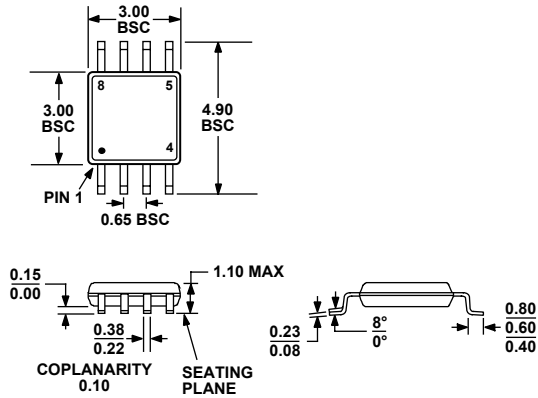

COMPLIANT TO JEDEC STANDARDS MO-187AA

Figure 59. 8-Lead Small Outline IC [SOIC] (RM-8)—Dimensions shown in millimeters

ORDERING GUIDE

Model	Temperature Package	Package Description	Package Option	Branding
AD8698ARM-R2	-40°C to +85°C	MSOP	RM-8	A02
AD8698ARM-REEL	-40°C to +85°C	MSOP	RM-8	A02
AD8698AR	-40°C to +85°C	SOIC	R-8	
AD8698AR-REEL	-40°C to +85°C	SOIC	R-8	
AD8698AR-REEL7	-40°C to +85°C	SOIC	R-8	

AD8698

NOTES

NOTES

AD8698

NOTES